



Siesta 1 features integral seats.

Siesta

79.5" x 48" x 22.5"

GENERAL SPECIFICATIONS:

Material - Acrylic

Installation - Drop-in (cannot be undermounted)
Not recommended as a tub / shower combination.

Plumbed Weight - 185 lbs / 84 kg

Soaker Weight - 120 lbs / 55 kg

Average Fill - 54 gal to above jet level

Maximum Fill - 107 gal to overflow

NOTE: Filling this tub to the maximum may require an above average size or dedicated water heater.

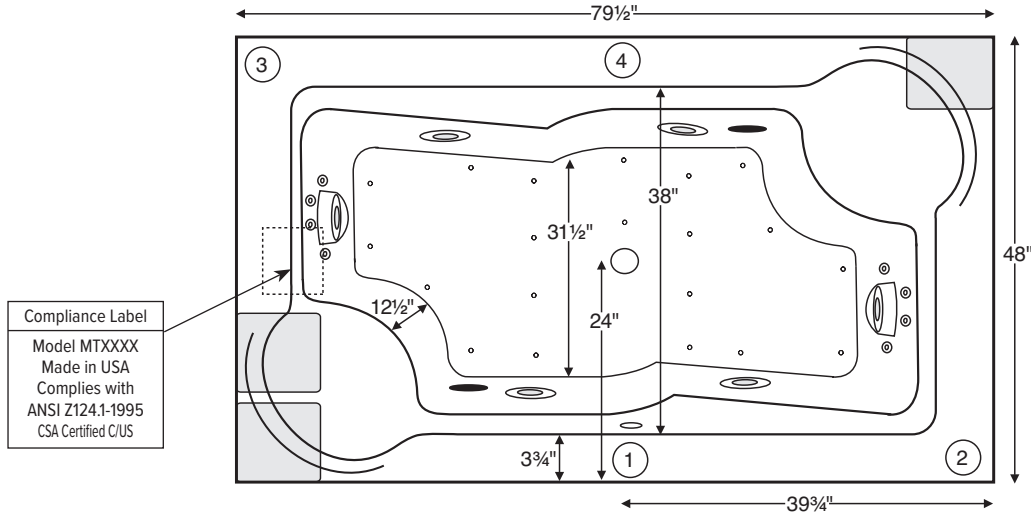

Compliance Label
Model MTXXXX
Made in USA
Complies with
ANSI Z124.1-1995
CSA Certified C/US

Numbered areas on tub deck represent possible locations to install cleaning systems, faucets and other fixtures.

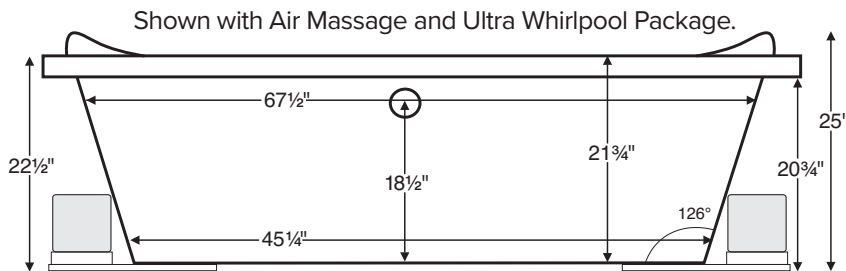

Shown with Air Massage and Ultra Whirlpool Package.

IMPORTANT:
Air baths and tubs with a pre-leveled foam base or frame system add 2-3" to overall tub height.

ELECTRICAL COMPONENTS & SPECIFICATIONS		
Required Electrical Service - 110 Volt		
Hydrotherapy Package	Components Included	GFCI
Standard Whirlpool	2-bhp pump, inline heater	2-15 amp
Ultra Whirlpool	2 2-bhp pumps, inline heater	2-20 amp
Air Massage	heated blower	1-15 amp
Air Massage Elite	heated blower, chromatherapy	1-15 amp
Air Massage with Standard Whirlpool	2-bhp pump, inline heater, heated blower	1-15 amp 2-20 amp
Air Massage with Ultra Whirlpool	2 2-bhp pumps, inline heater, heated blower	2-20 amp
Air Massage Elite with Standard Whirlpool	2-bhp pump, inline heater, heated blower, chromatherapy	1-15 amp 1-20amp
Air Massage Elite with Ultra Whirlpool	2 2-bhp pumps, inline heater, heated blower, chromatherapy	2-20 amp

For electrical requirements of tub options, see specific options specs
CSA Certified C/US; ANSI Z124.1 for plastic tubs and ANSI 112.19.7 for whirlpool components.

IMPORTANT ORDERING & INSTALLATION INFORMATION:

- Before ordering or installing, please consider future access to equipment.
- Add bedding compound to fully level and support bottom of tub.
- Tubs equipped with an air bath or a pre-leveled foam base are designed to rest on the floor *without* bedding compound, provided the floor is level.
- **Overall tub height is increased by approx. 2-3" when tub is equipped with any air bath package or when pre-leveled foam base or frame system is ordered.**
- Radiance placed on floor locations will affect placement of air jets.
- Please measure tub **on-site** before building tub decking.
- If you are planning to use a glass enclosure, MTI must be advised when ordering for possible relocation of controls.
- Suction and control locations may vary.
- Specifications and configurations are subject to change without notice.
- Measurements are $\pm 1/2"$ and are subject to change without notice.
- Measurements herein supersede all others published prior to publication date shown below.









See the "Designer Collection Tubs Installation & Operation Manual" included with tub delivery or go to mtibaths.com/support/installation_operation/manuals for all the information necessary to install and operate the tub.

MTI's Customer Service Department is available Monday-Friday 8am-6pm EST at 800-783-8827 or customerservice@mtibaths.com to answer any questions pertaining to ordering or installation.



Packages and Pricing

For more information on any of the following packages, please visit: mtibaths.com/therapies-for-wellness/

Hydrotherapy Packages	Package Contents	Part #	MSRP
 Soaker	Soaking bath - no jets, textured bottom	S33	\$2,740
 Air Massage	20 air jets, heated air blower, Aromatherapy, pre-leveled foam base (increases overall height 2-3"), textured bottom	AST33	\$5,555
 Air Massage Elite	30 air jets, heated air blower, Aromatherapy, Chromotherapy LED lighting, Spa Mode, pre-leveled foam base (increases overall height 2-3"), textured bottom	AE33	\$7,285
 Standard Whirlpool	6 point-massage jets, 2-bhp pump, inline heater, textured bottom	P33	\$5,315
 Ultra Whirlpool	6 point-massage jets, 8 micro-jets with Tsubo massage, 2 2-bhp pumps, inline heater, Ozone, textured bottom	P33U	\$7,230
 Air Massage with Standard Whirlpool	6 point-massage jets, 2-bhp pump, inline heater, 20 air jets, heated air blower, Aromatherapy, pre-leveled foam base (increases overall height 2-3"), textured bottom	AW33	\$7,725
 Air Massage with Ultra Whirlpool	6 point-massage jets, 8 micro jets with Tsubo massage, 2 2-bhp pumps, inline heater, 20 air jets, heated air blower, Aromatherapy, Ozone, pre-leveled foam base (increases overall height 2-3"), textured bottom	AU33	\$9,595
 Air Massage Elite with Standard Whirlpool	6 point-massage jets, 2-bhp pump, inline heater, 30 air jets, heated air blower, Aromatherapy, Chromotherapy LED lighting, Spa Mode, pre-leveled foam base (increases overall height 2-3"), textured bottom	AEAP33	\$9,840
 Air Massage Elite with Ultra Whirlpool	6 point-massage jets, 8 micro-jets with Tsubo massage, 2 2-bhp pumps, inline heater, 30 air jets, heated air blower, Aromatherapy, Ozone, Chromotherapy LED lighting, Spa Mode, pre-leveled foam base (increases overall height 2-3"), textured bottom	AEAP33U	\$11,590

Lead Time - Soakers, Stream Bath and Whirlpool Packages - 5 business days
Air Baths and Combo Packages - 7 business days

NOTES: • Aromatherapy is eliminated for undermount applications
• Air Baths, Pre-Leveled Foam Base or Frame Systems increase overall height by 2-3".

RECOMMENDED SENSORY THERAPIES

SEE NEXT PAGE FOR AN OVERVIEW OF AVAILABLE OPTIONS.



Chromotherapy
Underwater lighting is provided by digitally controlled LEDs. Different colors are thought to have different therapeutic effects.

LE - \$610



Audiotherapy
Stereo H₂O lets you "feel" the music through the bath water. Available with Bluetooth system or transducers with leads to connect to an external system.

STEREOH202 - \$1,135
STEREOBT - \$1,235



Thermotherapy
Radiance uses integrated radiant heat to warm the backrest for neck, shoulders and back. Inline heaters maintain bath water temperature.

RAD100 - \$1,080
HTISOAK - \$750



Microbubbles
For wellness and beauty, billions of the tiniest air bubbles saturate the water with dissolved oxygen to moisturize and soften the skin. Available for soakers and air baths.

MICRO - \$1,745



Options and Pricing

For more information on any of the following options, please visit: mtibaths.com/tub-options/

Premium Options

NOTE: part codes for all options listed in parenthesis.

Microbubbles - Available on Soakers and Air Baths only
(MICRO) **\$1,745**
System components may extend up to 5" beyond perimeter of the tub.

Radiance - integrated tub shell heating system
(RAD100) **\$1,080**

Chromatherapy - Included in some hydrotherapy packages
underwater LED lighting (LE) **\$610**

Stereo H₂O - Standard System - includes 4 integrated audio transducers with leads to connect to an external audio source
(STEREOH202) **\$1,135**
Bluetooth System - integrated Bluetooth system allows you to directly connect to an applicable device
(STEREOBT) **\$1,235**

Standard Options

Standard Colors: White (CWH), Bone (CBN), Biscuit (CBS)
Color Upgrade: (COL2) **\$500**, please call for availability of special colors

Quick Ship - reduces lead time - please call for availability
(QSPRI) **\$380**

Virtual Spout - high-flow integrated tub filler
(FPMJ) **\$310**

Inline Heater - included in some hydrotherapy packages
For whirlpools or Stream Bath (HTI) **\$545**
Uses existing pump
Soaker or Air Baths (HTISOAK) **\$750**
Includes a recirculating pump.

Installation Aids

Tile Flange must specify flange location(s) on order
Note: Tile flange not available with Low-Profile Rim option.
Factory-Installed on 3 sides - rigid ABS (TFK3) **\$190**
Field Install Kit - includes rigid ABS & adhesive (TFKNI) **\$175**

Pre-Leveled Foam Base - for soaker or whirlpools (PLFOAM) **\$175**

Pre-Leveled Frame and Foam Base (PLF) **\$525**

Pre-Leveled Frame and Foam Base with Skirt
Acrylic Contemporary Euro-Style with Removable Panels
(FSKE65) **\$1,350**



Optional Acrylic Contemporary Euro-Style Skirt

Accessories & Hardware for All Packages

Drain Kits - other finishes also available

Toe-Tap with Slim-Line Integrated Overflow

Choose from: Chrome (SLOT), Brushed Nickel (SLOTBN),
Polished Nickel (SLOTPN) or White (SLOTWH) **\$390**

Toe-Tap with Rectangular Overflow -

Chrome (WOTRC) **\$285**
Brushed Nickel (WOTRBN) **\$290**
White (WOTRW) **\$290**

Toe-Tap with Round Overflow -

Chrome (WOTTC) **\$285**
Brushed Nickel (WOTTBN) **\$290**
Polished Nickel (WOTTPN) **\$340**

Cable Driven -

Chrome (WOCD) **\$315**
Brushed Nickel (WOCDBN) **\$385**
Polished Nickel (WOCDPN) **\$515**
Oil-Rubbed Bronze (WOCBOR) **\$515**

Lift & Turn - Chrome (WOC) **\$125**

Brushed Nickel (WOBN) **\$225**

Grab Bars - 9" Curved, set of 2

Acrylic - color-matched with tub
standard colors only (GB) **\$300**
Metal - Chrome (GBMCC), Brushed Nickel (GBMCBN) **\$330**

Pillows - from **\$125** See pillows pricing and specs online.

Teak Tub Tray - Slatted (TK-TRAY1) or Solid (TK-TRAY2) **\$415**

Teak Bath Mat (TK-MAT3018) **\$430** custom sizes also available

Accessories & Cleaning Systems for Whirlpool Packages

Trim Kits - must be ordered at time of purchase; other finishes available

Standard Whirlpool - Chrome (TRC) **\$235**; Brushed Nickel (TRBN) **\$595**
Ultra Whirlpool - Chrome (TRCU) **\$320**; Brushed Nickel (TRBNU) **\$815**

Pump Upgrade - 3-bhp (PUMP3) **\$245**

Additional Jet Options See jet options pricing and specs online.

Whirlpool Cleaning Systems -

Fill-Flush (FFSO) **\$590**; Simple Touch (FFE) **\$710**

Ozonator - bath water purification system (OZONE) **\$535**