

Designer Collection Tubs

Charlotte

MODEL # 400
65.5" x 32" x 22.5"

GENERAL SPECIFICATIONS

Material - Mineral Composite

Installation - Freestanding - *cannot be undermounted*
Not recommended as a tub / shower combination

Soaker Weight - 160 lbs / 73 kg

Maximum Fill - 67 gal to overflow

NOTE: *Filling this tub to the maximum may require an above average size or dedicated water heater.*



Features an integrated overflow.

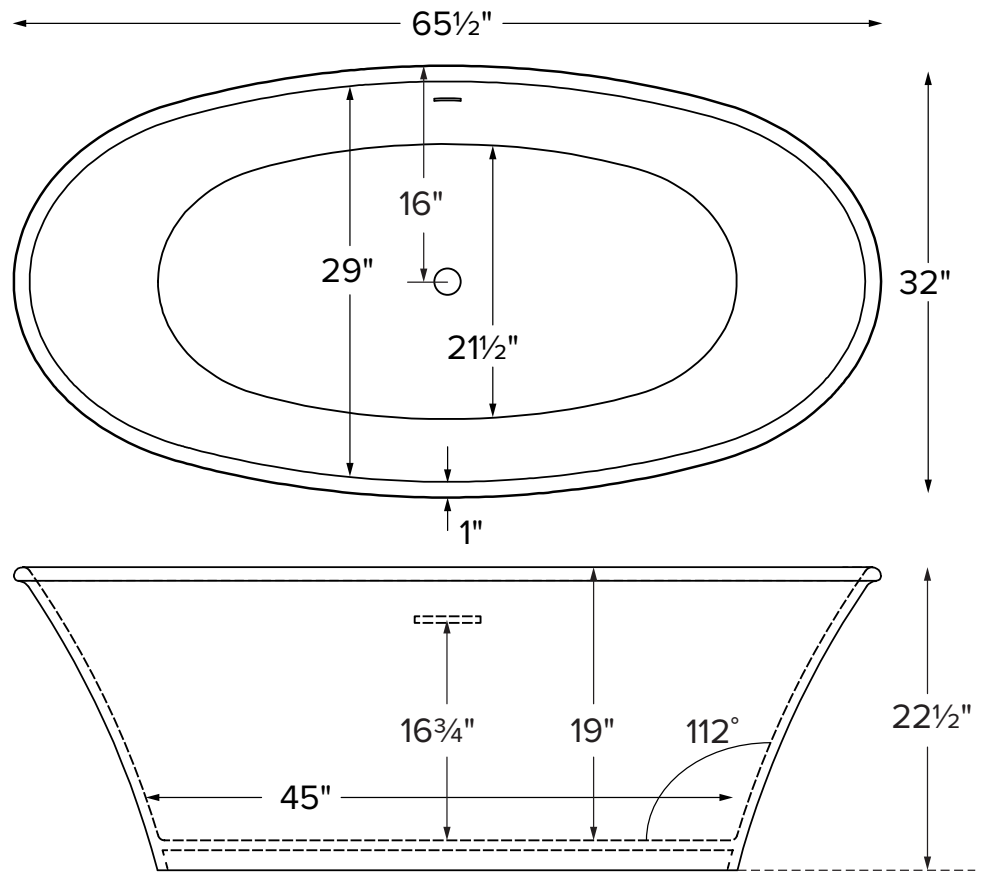

Drain Rough-In Measurement

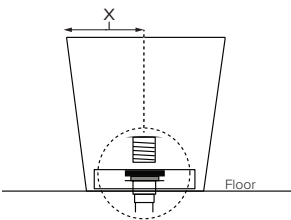

ELECTRICAL COMPONENTS & SPECIFICATIONS

Required Electrical Service - 110 Volt

Hydrotherapy Package	Components Included	GFCI
Air Massage	heated blower	1-15 amp

CSA Certified C/US; ANSI Z124.1 and ANSI 112.19.7

See the Installation & Operation Manual for more details.
MTI's Customer Service: Monday-Friday 8am-6pm EST
800-783-8827 or service@mtibaths.com

IMPORTANT ORDERING & INSTALLATION INFORMATION

- Before ordering or installing, please consider future access to equipment.
- Integrated overflow with toe tap drain included. May also be specified without an overflow (see local codes).
- Air baths require job site preparations for remote mounting the blower and required check valve. Check valve must be installed higher than the rim of the tub.
- Waterproof remote control included. Keypad is shipped loose and may be mounted nearby.
- Faucet valves cannot be installed on this tub model.

• Options and accessories may be packaged inside the tub crate. Always check packaging before discarding.
• All product measurements are $\pm 1/2"$.
• Specifications and configurations are subject to change without notice.
• Measurements herein supersede all others published prior to publication date below.



For more information on options and accessories go to Designer Mineral Composite Tubs Options on mtibaths.com

- Blower & required check valve for airbath must be remote mounted
- Check valve must be installed higher than the rim of the tub.

Charlotte
MODEL # 400
65.5" x 32" x 22.5"

Hydrotherapy	Package Contents	Part #	MSRP	
Soaker	Soaking bath - no jets. Includes an integrated slotted overflow with toe-tap drain kit.	S400	\$6,100	Crate / Handling Fee Applies
Air Bath	20 air jets, heated air blower, keypad, waterproof remote control, integrated slotted overflow with toe-tap drain kit.	AST400	\$10,000	Crate / Handling Fee Applies

Options
<i>Must be ordered at time of purchase</i>
Standard Colors White, gloss finish only
Quick Ship reduces lead time (QSPRI) \$380 <i>Please call for availability</i>

Drains
<i>Must be ordered at the time of purchase</i>
Integrated Overflow and Toe-Tap Drain Kit Finishes PVC drain - White (included with tub) Substitute Finish - No Charge Chrome (MCIOC) Brushed Nickel (MCIOBN) Polished Nickel (MCIOPN)
Brass Tailpiece (WIOBS) \$65 in addition to finish charge listed above
Quick Drain Kit (WOQ) \$410



Inside view of tub

Accessories				
Floor-Mounted High-Flow Tub Filler two designs available				
<table border="0"> <tr> <td>Contemporary Chrome (FILLC) \$1,410 Brushed Nickel (FILLBN) \$1,630</td> <td>Traditional Chrome (FILLTC) \$1,435 Brushed Nickel (FILLTBN) \$1,660</td> </tr> </table>	Contemporary Chrome (FILLC) \$1,410 Brushed Nickel (FILLBN) \$1,630	Traditional Chrome (FILLTC) \$1,435 Brushed Nickel (FILLTBN) \$1,660		
Contemporary Chrome (FILLC) \$1,410 Brushed Nickel (FILLBN) \$1,630	Traditional Chrome (FILLTC) \$1,435 Brushed Nickel (FILLTBN) \$1,660			
Pillows from \$145				
Teak Bath Mat (TKMAT3018) \$650 <i>Custom sizes also available. Contact MTI for details and pricing.</i>				
Tub Tray SculptureStone® – Available in white only Solid without stemware holder (SSTRAY1) \$400 Solid with Stemware Holder (SSTRAY2) \$400				
Bathroom Table SculptureStone® Packaging / Handling Fee Applies (TABLE) \$730 available in white only +\$380 gloss finish upcharge (SSGLOSSSNK)				
Faucet Stand SculptureStone® Standard Packaging / Handling Fee Applies				
<table border="0"> <tr> <td>Small 3-hole capacity 14¼" w x 21¾" h Matte (STAND) \$640</td> <td>Large 5-hole capacity 22" w x 21¾" h Matte (STANDL) \$750</td> </tr> </table>	Small 3-hole capacity 14¼" w x 21¾" h Matte (STAND) \$640	Large 5-hole capacity 22" w x 21¾" h Matte (STANDL) \$750		
Small 3-hole capacity 14¼" w x 21¾" h Matte (STAND) \$640	Large 5-hole capacity 22" w x 21¾" h Matte (STANDL) \$750			
+\$380 gloss finish upcharge (SSGLOSSSNK)				
Premium Faucet Stand SculptureStone® Packaging / Handling Fee Applies				
<table border="0"> <tr> <td>15" w x 39" h Matte (SSFSR3915MT) \$2,085 Gloss (SSFSR3915GL) \$2,400</td> <td>10" w x 39" h Matte (SSFSR3910MT) \$1,880 Gloss (SSFSR3910GL) \$2,230</td> </tr> <tr> <td>20" w x 23" h Matte (SSFSR2320MT) \$1,700 Gloss (SSFSR2320GL) \$2,045</td> <td>15" w x 23" h Matte (SSFSR2315MT) \$1,610 Gloss (SSFSR2315GL) \$1,925</td> </tr> </table>	15" w x 39" h Matte (SSFSR3915MT) \$2,085 Gloss (SSFSR3915GL) \$2,400	10" w x 39" h Matte (SSFSR3910MT) \$1,880 Gloss (SSFSR3910GL) \$2,230	20" w x 23" h Matte (SSFSR2320MT) \$1,700 Gloss (SSFSR2320GL) \$2,045	15" w x 23" h Matte (SSFSR2315MT) \$1,610 Gloss (SSFSR2315GL) \$1,925
15" w x 39" h Matte (SSFSR3915MT) \$2,085 Gloss (SSFSR3915GL) \$2,400	10" w x 39" h Matte (SSFSR3910MT) \$1,880 Gloss (SSFSR3910GL) \$2,230			
20" w x 23" h Matte (SSFSR2320MT) \$1,700 Gloss (SSFSR2320GL) \$2,045	15" w x 23" h Matte (SSFSR2315MT) \$1,610 Gloss (SSFSR2315GL) \$1,925			

