

# Deborah 2

## 42.25" x 42.25" x 18.5"



### GENERAL SPECIFICATIONS:

- Material** - Acrylic
- Installation** - Drop-in or Undermount
- Plumbed Weight** - 112 lbs / 51 kg
- Soaker Weight** - 87 lbs / 40 kg
- Average Fill** - 40 gal to above jet level
- Maximum Fill** - 60 gal to overflow

NOTE: Filling this tub to the maximum may require an above average size or dedicated water heater.

PLEASE NOTE: This tub is very small and is intended for applications where space is extremely limited.

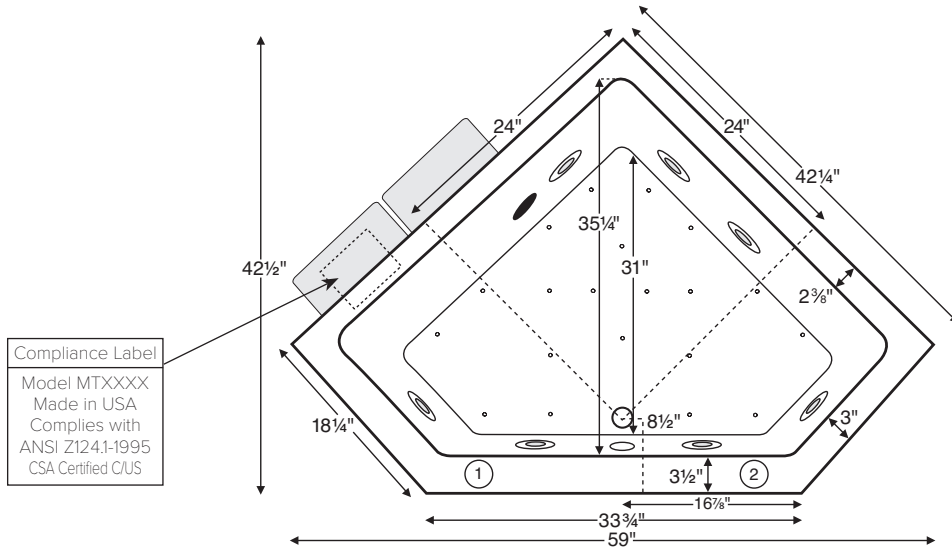

Compliance Label  
Model MTXXXX  
Made in USA  
Complies with  
ANSI Z124.1-1995  
CSA Certified CUS

Numbered areas on tub deck represent possible locations to install cleaning systems, faucets and other fixtures.  
**Pump extends 6" beyond edge of tub.**

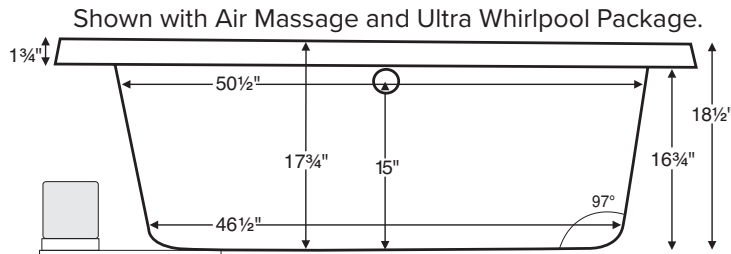

**IMPORTANT:**  
Air baths and tubs with a pre-leveled foam base or frame system add 2-3" to overall tub height.

### ELECTRICAL COMPONENTS & SPECIFICATIONS

Required Electrical Service - 110 Volt

Hydrotherapy Package	Components Included	GFCI
Standard Whirlpool	2-bhp pump	1-15 amp
Ultra Whirlpool	2 2-bhp pumps, inline heater	2-20 amp
Air Massage	heated blower	1-15 amp
Air Massage Elite	heated blower, chromatherapy	1-15 amp
Air Massage with Standard Whirlpool	2-bhp pump, heated blower	2-15 amp
Air Massage with Ultra Whirlpool	2 2-bhp pumps, inline heater, heated blower	2-20 amp
Air Massage Elite with Standard Whirlpool	2-bhp pump, heated blower, chromatherapy	2-15 amp
Air Massage Elite with Ultra Whirlpool	2 2-bhp pumps, inline heater, heated blower, chromatherapy	2-20 amp

Electrical requirements may change with the addition of optional therapy components. See installation manual for more details.

CSA Certified C/US; ANSI Z124.1 and ANSI 112.19.7.

### IMPORTANT ORDERING & INSTALLATION INFORMATION:









- Before ordering or installing, please consider future access to equipment.
- Add proper bedding compound to fully level and support bottom of tub.
- Tubs equipped with an air bath or a pre-leveled foam base are designed to install on a flat, level subfloor without bedding compound.
- **Overall tub height is increased by approx. 2-3" when tub is equipped with any air bath package or when pre-leveled foam base or frame system is ordered.**
- Radiance placed on airbath floor will affect placement of air jets.
- When ordering Microbubbles, system components will extend beyond the perimeter of tub.
- Please measure tub **on-site** before building tub decking.
- If you are planning to use a glass enclosure, advised MTI when ordering. Relocation of controls may be necessary.
- Suction and control locations may vary.
- Specifications and configurations are subject to change without notice.
- Measurements are  $\pm 1/2"$  and are subject to change without notice.
- Measurements herein supersede all others published prior to publication date shown below.

See the [Installation & Operation Manual](#) for Designer Series Air & Whirlpool Tubs for more details.  
MTI's Customer Service Department • Monday-Friday 8am-6pm EST • 800-783-8827  
or [service@mtibaths.com](http://service@mtibaths.com)



## Packages and Pricing

For more information on any of the following packages, please visit: [mtibaths.com/therapies-for-wellness/](http://mtibaths.com/therapies-for-wellness/)

Hydrotherapy Packages	Package Contents	Part #	MSRP
 Soaker	Soaking bath - no jets	S90-DI	\$1,575
		S90-UM	
 Air Massage	20 air jets, heated air blower, Aromatherapy, pre-leveled foam base (increases overall height 2-3") <i>*note blower will stick out 6"</i>	AST90-DI	\$4,390
		AST90-UM	
 Air Massage Elite	30 air jets, heated air blower, Aromatherapy, Chromotherapy LED lighting, Spa Mode, pre-leveled foam base (increases overall height 2-3") <i>*note blower will stick out 6"</i>	AE90-DI	\$6,120
		AE90-UM	
 Standard Whirlpool	6 point-massage jets, 2-bhp pump <i>*note pump will stick out 6"</i>	P90-DI	\$3,075
		P90-UM	
 Ultra Whirlpool	7 point-massage jets, 2-bhp pump, inline heater, Ozone <i>*note pump will stick out 6"</i>	P90U-DI	\$4,010
		P90U-UM	
 Air Massage with Standard Whirlpool	6 point-massage jets, 2-bhp pump, 20 air jets, heated air blower, Aromatherapy, pre-leveled foam base (increases overall height 2-3") <i>*note pump &amp; blower will stick out 6"</i>	AW90-DI	\$5,980
		AW90-UM	
 Air Massage with Ultra Whirlpool	7 point-massage jets, 2-bhp pump, inline heater, 20 air jets, heated air blower, Aromatherapy, Ozone, pre-leveled foam base (increases overall height 2-3") <i>*note pump &amp; blower will stick out 6"</i>	AU90-DI	\$6,590
		AU90-UM	
 Air Massage Elite with Standard Whirlpool	6 point-massage jets, 2-bhp pump, 30 air jets, heated air blower, Aromatherapy, Chromotherapy LED lighting, Spa Mode, pre-leveled foam base (increases overall height 2-3") <i>*note pump &amp; blower will stick out 6"</i>	AEAP90-DI	\$7,335
		AEAP90-UM	
 Air Massage Elite with Ultra Whirlpool	7 point-massage jets, 2-bhp pump, inline heater, 30 air jets, heated air blower, Aromatherapy, Ozone, Chromotherapy LED lighting, Spa Mode, pre-leveled foam base (increases overall height 2-3") <i>*note pump &amp; blower will stick out 6"</i>	AEAP90U-DI	\$8,050
		AEAP90U-UM	

**Lead Time** - Soakers, Stream Bath and Whirlpool Packages - 5 business days  
Air Baths and Combo Packages - 7 business days

**NOTES:** • Aromatherapy is eliminated for undermount applications  
• Air Baths, Pre-Leveled Foam Base or Frame Systems increase overall height by 2-3".

### RECOMMENDED SENSORY THERAPIES

SEE NEXT PAGE FOR AN OVERVIEW OF AVAILABLE OPTIONS.



**Chromotherapy**  
Underwater lighting is provided by digitally controlled LEDs. Different colors are thought to have different therapeutic effects.

LE - \$610



**Audiotherapy**  
Stereo H<sub>2</sub>O lets you "feel" the music through the bath water. Available with Bluetooth system or transducers with leads to connect to an external system.

STEREOH202 - \$1,135  
STEREOBT - \$1,235



**Thermotherapy**  
Radiance uses integrated radiant heat to warm the backrest for neck, shoulders and back. Inline heaters maintain bath water temperature.

RAD100 - \$1,080  
HTISOAK - \$750



**Microbubbles**  
For wellness and beauty, billions of the tiniest air bubbles saturate the water with dissolved oxygen to moisturize and soften the skin. Available for soakers and air baths.

MICRO - \$1,745



## Options and Pricing

For more information on any of the following options, please visit: [mtibaths.com/wellness/](http://mtibaths.com/wellness/)

### Premium Options

Electrical requirements may change with the addition of optional therapies. See [installation instructions](#) for more details.

#### Microbubbles (MICRO) \$1,745

NOTE: Available on Soakers and Air Baths only. Cannot be combined with Inline Heater. System components may extend up to 5" beyond perimeter of the tub.

#### Radiance - integrated tub shell heating system (RAD100) \$1,080

#### Chromatherapy - underwater LED lighting (LE) \$610

Included with some hydrotherapy packages.

#### Stereo H<sub>2</sub>O - audiotherapy

##### Standard System (STEREOH202) \$1,135

##### Bluetooth System (STEREOBT) \$1,235

### Standard Options

#### Standard Colors - White (CWH), Bone (CBN), Biscuit (CBS)

#### Color Upgrade (COL2) \$500

Please call for availability of special colors.

#### Quick Ship - reduces lead time (QSPRI) \$380

Please call for availability.

#### Textured, Slip-Resistant Bottom (TXBTM) \$75

Compliant with ASTM C 1028-07 friction coefficient.

#### Virtual Spout - high-flow integrated tub filler (FPMJ) \$310

#### Inline Heater - maintains water temperature

#### For whirlpools or Stream Bath (HTI) \$545

Uses existing pump

#### Soaker or Air Baths (HTISOAK) \$750

Includes a recirculating pump

NOTE: Some hydrotherapy packages include an inline heater. Electrical requirements will change with the addition of Inline Heater. Cannot be combined with Microbubbles.

### Installation Aids

#### Tile Flange

##### Factory-Installed on 2 sides - rigid ABS (TFKC) \$190

##### Field Install Kit - includes rigid ABS & adhesive (TFKNI) \$175

**IMPORTANT:** Factory-Installed Tile Flange standard location is along the sides of the tub extending from the rear corner. Must specify any custom flange locations.

#### Pre-Leveled Foam Base (PLFOAM) \$175

For soakers and whirlpools. All airbaths include a pre-leveled foam base.

#### Pre-Leveled Frame and Foam Base (PLFC) \$635

### Accessories & Hardware for All Packages

#### Drain Kits - other finishes also available

#### Toe-Tap with Slim-Line Integrated Overflow \$390

Chrome (SLOT), Brushed Nickel (SLOTBN),  
Polished Nickel (SLOTPN) or White (SLOTWH)

#### Toe-Tap with Rectangular Overflow

Chrome (WOTRC) \$285, Brushed Nickel (WOTRBN) \$290  
White (WOTRW) \$290

#### Toe-Tap with Round Overflow

Chrome (WOTTC) \$285, Brushed Nickel (WOTTBN) \$290  
Polished Nickel (WOTTPN) \$340

#### Cable Driven

Chrome (WOCD) \$315, Brushed Nickel (WOCDNB) \$385  
Polished Nickel (WOCDPN) \$515  
Oil-Rubbed Bronze (WOCDOR) \$515

#### Lift & Turn

Chrome (WOC) \$125, Brushed Nickel (WOBN) \$225

#### Grab Bars - 9" Curved, set of 2

#### Acrylic - Color-Matched (GB) \$300

NOTE: Acrylic grab bars available in standard colors only.

#### Pillows - from \$125 [See details and pricing](#)

#### Teak Bath Mat (TKMAT3018) \$430

Custom sizes also available. Contact MTI for details and pricing.

### Accessories & Cleaning Systems for Whirlpool Packages

#### Trim Kits

##### For Standard Whirlpool

Chrome (TRC) \$235, Brushed Nickel (TRBN) \$595

##### For Ultra Whirlpool

Chrome (TRCU) \$320, Brushed Nickel (TRBNU) \$815

Must be ordered at time of purchase. Other finishes available.

#### Pump Upgrade - 3-bhp (PUMP3) \$245

#### Additional Jet Options [See details and pricing](#)

#### Whirlpool Cleaning Systems

##### Fill-Flush (FFSO) \$590

##### Simple Touch (FFE) \$710

#### Ozonator - bath water purification system (OZONE) \$535

